

NATIVE FROG CAPTIVE HUSBANDRY MANUAL

Prepared by: Nadia Webster
Department of Conservation

Date: 23 May 2004
Draft number: 1.0

Review

Draft number	Date	Reviewer's name	Organisation	Changes made

<i>Native Frog Captive Husbandry Manual</i>	<i>i</i>
1 Introduction	1
1.1 Taxonomy	1
1.2 Conservation status.....	1
1.3 Legal protection	1
1.4 Context of husbandry manual.....	1
1.4.1 Declining amphibian populations	1
1.4.2 Evidence of Chytrid fungus in New Zealand	2
1.4.3 Establishment of captive populations	2
1.4.4 Objectives of captive populations.....	3
1.5 Captive Management Co-ordinator.....	3
2 Identification method	3
2.1 Individual identification	3
2.2 Sex determination	4
3 Natural History	4
3.1 Distribution.....	4
3.2 Unique physiology	5
3.3 Habitat preference	5
3.4 Antipredator behaviour.....	5
4 Facilities	5
4.1 Construction of facilities.....	5
4.2 Housing for terrestrial species (<i>Leiopelma archeyi</i> , <i>L. hamiltoni</i> , <i>L. pakeka</i>)	7
4.2.1 Densities	7
4.2.2 Substrate and Refuge	7
4.2.3 Water	9
4.2.4 Humidity	9
4.2.5 Lighting	9
4.2.6 Temperature.....	9
4.3 Housing for semi-aquatic species (<i>Leiopelma hochstetteri</i>)	10
4.3.1 Densities	11
4.3.2 Substrate and Refuge	11
4.3.3 Water	11
4.3.4 Humidity.....	11
4.3.5 Lighting	11
4.3.6 Temperature.....	11
4.4 Cleaning.....	12
5 Diet	13
5.1.1 Adult frogs.....	13
5.1.2 Juvenile frogs	13
6 Quarantine procedures	14
6.1 Quarantine	14
6.1.1 Wild to captive facility.....	14
6.2 Isolation.....	14

6.3	Hygiene.....	14
6.4	Housing	14
6.4.1	Space and substrate.....	15
6.4.2	Lighting.....	15
6.5	Climate.....	15
6.5.1	Scenario 1: Chytrid test and/or chytrid treatment is expected to become available.....	15
6.5.2	Scenario 2: No chytrid test or treatment is expected to become available	16
6.6	Transportation.....	17
6.6.1	Packing for transport.....	17
6.6.2	Transportation between sites	18
6.6.3	On arrival at captive facility.....	18
7	<i>Reproduction</i>	18
7.1	Breeding	19
7.1.1	Breeding Behaviour	19
7.1.2	Breeding season.....	19
7.1.3	Stimuli to breed	19
7.1.4	Oviposition sites.....	20
7.1.5	Amplexus.....	20
7.1.6	Egg clusters	21
7.1.7	Fertility rates.....	21
7.2	Rearing.....	21
7.2.1	Parental care.....	21
7.2.2	Egg and larval development.....	22
7.2.3	Incubation of eggs and larvae	23
7.2.4	Nursery terraria.....	24
7.3	Recommended readings	24
8	<i>Handling frogs</i>	24
9	<i>Medical Issues</i>	24
9.1	Health assessment.....	24
9.2	Main health problems.....	25
9.2.1	Cutaneous Chytridiomycosis.....	25
9.2.2	Ranaviruses.....	25
9.2.3	Red Leg	25
9.2.4	Parasites	25
9.3	Notes on Mortality.....	25
9.4	Death and disposal.....	26
10	<i>Records and reporting</i>	26
11	<i>Research needs</i>	27
12	<i>Key contacts</i>	28
12.1	General Husbandry.....	28
12.2	Breeding and Rearing.....	28
12.3	Permits	28
12.4	Health and disease.....	28
12.5	Diagnostic centres for analysis of dead frogs.....	28
13	<i>Acknowledgements</i>	29

14 *References* **29**

15 *Appendices*..... **33**

15.1 Appendix 1: Seasonal temperature ranges 33

15.2 Appendix 2: Toad Ringer solution 34

15.3 Appendix 3: Dead frog submission form 35

1 INTRODUCTION

The principal audience for this document are employees of the Department of Conservation and any external organisation or individual with an interest or intent to keep and maintain *Leiopelma* frogs in captivity.

As more is learnt about the captive maintenance of New Zealand's native frogs this manual will be updated.

1.1 TAXONOMY

Class: Amphibia
 Superorder: Lissamphibia
 Order: Salienta (Anura)
 Suborder: Lemnanura
 Family: Leiopelmatidae
 Genus: *Leiopelma*
 Species:

Extant:
 Hochstetter's frog – *hochstetteri*
 Archey's frog – *archeyi*
 Hamilton's frog – *hamiltoni*
 Maud Island frog – *pakeka*

Extinct:
 Aurora frog – *auroraensis*
 Markham's frog – *markhami*
 Waitomo frog - *waitomoensis*

Leiopelma is considered one of the most ancient of all living amphibian genera. Their nearest but distant living relative is the North American tailed frog, *Ascaphus truei* (Green et al. 1989; Hay et al. 1995).

1.2 CONSERVATION STATUS

Species	DOC threat classification (Molloy et al. 2002)	IUCN status
<i>L. hochstetteri</i>	6. Sparse	Low Risk (Least Concern)
<i>L. archeyi</i>	1. Nationally Critical	Low Risk (Near Threatened)
<i>L. hamiltoni</i>	1. Nationally Critical	Vulnerable (D2)
<i>L. pakeka</i>	2. Nationally Endangered	Vulnerable

1.3 LEGAL PROTECTION

All *Leiopelma* species are absolutely protected under the Wildlife Act 1953, therefore a permit is required from the Department of Conservation prior to the handling or collection of any *Leiopelma* frogs.

1.4 CONTEXT OF HUSBANDRY MANUAL

1.4.1 Declining amphibian populations

Since the 1980's, there has been alarm over the widespread decline of amphibian populations in areas such as North America, and more recently Australia. However, an observed decline has now been documented in New Zealand for populations of both native and exotic frog species (Bell 1999, 2001; Waldman 2001).

Of concern, many of the regions where amphibian declines have been recorded are considered near-pristine environments and causal agents such as habitat destruction and invasion of exotic species have been considered unlikely. During the 1990's, other potential agents began to be considered including changes in the environment (i.e. global warming and increased UV-B) and increases in pathogens.

The emerging disease chytridiomycosis has recently been considered the cause of several mass declines in amphibian populations in Central, South and North America, Australia (Daszak et al. 1999) and New Zealand (Waldman 2001). Although other pathogens have been identified as infectious agents in amphibians, chytridiomycosis has been identified as causing simultaneous and widespread effects over several taxa (Rabb 1999).

1.4.2 Evidence of Chytrid fungus in New Zealand

In late 1999 a Canterbury population of the exotic Australian frog, *Litoria raniformis*, was found to be in rapid decline. Histological tests confirmed the presence of chytrid fungus on sick and dead frogs from this population (Waldman 2001).

Since this discovery the Department of Conservation and other concerned parties have attempted to delineate the spread of chytrid fungus in both native and exotic frog populations.

Since mid 2001, dead *L. archeyi* specimens have been found within conservation areas (Mt. Moehau in the northern Coromandel, Tapu in central Coromandel and Whareorino Forest in the northern King Country). Specimens were found to be infected with chytrid fungus (Richard Norman, Massey University, pers. comm., Bruce Waldman, Canterbury University, pers. comm.). Populations of *L. archeyi* in the northern and central Coromandel have undergone dramatic declines in recent years (Bell 2001; Mitchell, Bell and Carver 2001; Ben Bell, Victoria University, pers. comm.) possibly due to widespread effects of chytrid infection.

As yet no *L. hamiltoni*, *L. pakeka* or *L. hochstetteri* infected with chytrid fungus have been found. However, all three are considered to be potentially at threat from chytrid infection. Until chytrid fungus was isolated from *L. archeyi* specimens the semi-aquatic *L. hochstetteri* was considered to be more likely to be threatened by chytrid fungus as it is known to infect frogs by its water-borne motile spore (zoospore).

1.4.3 Establishment of captive populations

All four species of *Leiopelma* have been successfully maintained and bred in captivity, but primarily for research purposes (Bell 1985a, 2002; Green 1986; Newman 1996). With evidence of chytrid fungus in native frog populations, it has been recommended that appropriate action be taken immediately to preserve and protect substantial numbers of *Leiopelma* in captivity in case wild populations fail to survive.

Much research on the reproductive behaviour and development of *Leiopelma* has already been reported (e.g. Archey 1922; Turbott 1949; N.G. Stephenson 1951a,b, 1955; Stephenson and Stephenson 1957, E.M. Stephenson 1961; Bull and Whitaker 1975, Bell 1977, 1978a,b, 1982a,b, 1985a, 2002).

There is an urgent need for research into the effect of chytrid fungus on *Leiopelma* frogs, based on captive stock, as well as to develop existing knowledge to maximise chances of

long-term survival of *Leiopelma* species in captivity, including captive breeding (which has been achieved) and rearing of progeny to adulthood (which was not the prime focus of previous research).

1.4.4 Objectives of captive populations

- **Short-term**

The immediate goal in establishing captive populations is the ex-situ preservation of *Leiopelma* species. Priority is given to individuals from chytrid free locations within populations in which evidence of chytrid infection has been found, and are therefore considered immediately threatened.

- **Long-term**

After establishment, the primary goals of captive populations are:

- maintaining ex-situ species preservation
- source of individuals for a captive breeding programme
- source of individuals for captive research, particularly in relation to species conservation
- source of individuals for establishment of new *Leiopelma* populations
- documentation and refinement of husbandry techniques

1.5 CAPTIVE MANAGEMENT CO-ORDINATOR

The Native Frog Recovery Group is still to appoint a National Native Frog Captive Co-ordinator. However, Tertia Thurley of DOC has been appointed the Archey's Frog Captive Co-ordinator.

2 IDENTIFICATION METHOD

2.1 INDIVIDUAL IDENTIFICATION

The identification of captive individuals is pertinent to the successful keeping of accurate records for each frog. It becomes especially important when individuals are put together for the purpose of mating where the assessment of parentage of offspring may be determined.

Possible methods of individual identification marking include toeclipping, pit tagging, photographing, elastomer implants and banded wire implants.

Toeclipping is the most widely used form of individual identification used on *Leiopelma* frogs in the wild. However, there are concerns over clipped toes providing a site of possible infection. In addition, Tangata whenua may have concerns regarding the intentional damage of a taonga. Pit tagging and banded wire implants may not be practical for such small frogs. Elastomer implants have been trialed on *L. pakeka* held in captivity at Otago University, but proved to be only useful with small numbers of frogs as implants tended to move around under the surface of the skin allowing only a few possible combinations of colours (Phil Bishop, Otago University, pers. comm.). Identifying individuals by photograph may only be useful for species with distinctive patterns (*L. hamiltoni*, *L. pakeka* and *L. archeyi*) and may be reliant on each frog being photographed at the same angle and depth of focus as each other frog.

At this stage no single identification method has been agreed upon for use in *Leioplema* captive management.

Auckland Zoo:

We will trial the photo identification system as discussed with DOC, Waikato.

It is felt that with a maximum of eight frogs per enclosure individuals will be able to be identified. If two frogs have similar markings they should, if possible, be housed in separate enclosures.

2.2 SEX DETERMINATION

It is difficult to determine the sex of any of the four species, and research is needed in this area. To date, sex has usually been determined by size, as females tend to be larger than males (Bell 1978a; Newman 1977a). This however, still leaves an element of doubt in the size ranges that may contain adult males and juvenile females. There is some evidence for sexual dimorphism in *L. hochstetteri*, with the males having thicker forelimbs (Bell 1978a, 2002).

It is possible to identify gravid females by inspecting under a bright light where the eggs can be seen through the pigmentation of the ventral abdominal wall (Newman 1977a; Bell 1978a, 2002). As the abdomen of a gravid female will be noticeably larger, handling can be kept to a minimum.

Preserved specimens that have been sexed fall into the following size ranges (after Bell 2002):

		SVL range (mm)
<i>L. hochstetteri</i>	Males	30-38
	Females	36-44
<i>L. archeyi</i>	Males	25-31
	Females	27-37
<i>L. pakeka/hamiltoni</i>	Males	37-43
	Females	42-47

Data from brooding males supports the size ranges as identified (Bell 2002).

Research is currently being undertaken at the University of Canterbury to ascertain if sex can be determined from chemical analysis of skin secretions or by ultrasound. Investigations at the University of Otago on the breeding behaviour of *L. pakeka* will also look at chemical and tactile communication.

3 NATURAL HISTORY

3.1 DISTRIBUTION

The four extant *Leiopelma* species are limited in range, and mostly occur as isolated remnant populations. *L. hamiltoni* is restricted to a 600m² rock bank on Stephens Island, and *L. pakeka* is from Maud Island and a new population has been translocated to Motuara Island. *L. hochstetteri* is found in scattered populations throughout the top third of the North Island as well as on Great Barrier Island. *L. archeyi* is found only in two areas, the Coromandel and Whareorino Forest in the northern King Country where they occur sympatrically with *L. hochstetteri* (Bell 1994).

3.2 UNIQUE PHYSIOLOGY

New Zealand native frogs are unique, having retained many primitive characteristics during their long period of development in isolation. This includes 'free' ribs (which are not fused to vertebrae), and tail wagging muscles in adults. They also lack the vocal sac and external eardrum present in many other frog species. Subsequently they can only hear low frequency sound.

3.3 HABITAT PREFERENCE

All species are terrestrial dwelling frogs, apart from *L. hochstetteri*, which is semi-aquatic in most of its range. Terrestrial forms of *L. hochstetteri* have also been recognised in Whareorino Forest (Eggers 1998). The four extant *Leiopelma* species are nocturnal, hiding under rocks, logs, in crevices and in vegetation by day and hunting for prey at night. However, they have sometimes been seen to emerge during the day.

L. archeyi are found in rocky outcrops and grassy clearings within moist native forest between 200 and 1000 m above sea level on mist covered ridge tops (Gill and Whitaker 1998). *L. hamiltoni* are found within a deep boulder bank on Stephen's Island and *L. pakeka* are found within coastal forest on Maud Island (Gill and Whitaker 1998). *L. hochstetteri* lives in shaded creek and seepage edges in native forest up to about 800 m above sea level (Gill and Whitaker 1998).

3.4 ANTIPREDATOR BEHAVIOUR

Antipredator behaviour in *Leiopelma* includes emitting chirps or squeaks, assuming a stiff-legged stance whilst rearing up, extending the legs and raising the body and butting the head, when under duress (Green 1988). *L. hochstetteri* is more apt at escape and does not display the aforementioned behaviours to the same extent. Each species has defensive granular glands in the skin, though distributed differently between the terrestrial species and *L. hochstetteri*, (Green 1988). The initial reaction to disturbance appears to be to remain immobile then to flee to the nearest retreat (Newman 1977b; Bell 1985a). *Leiopelma* also have cryptic colouration and nocturnal feeding regimes (Bell 1985a; Green 1988).

4 FACILITIES

4.1 CONSTRUCTION OF FACILITIES

Until further research is able to address threats such as chytrid fungus infection, it is recommended that all *Leiopelma* species collected from July 2002 for captive management be housed in indoor terraria only.

Indoor captive facilities are to be fitted into lockable rooms that are preferably separate from any other captive animal enclosures. The rooms must be sufficiently insulated in the walls, floors and ceiling to prevent any heating from the outside environment. If windows are necessary then they should be at least double glazed. Due to the high humidity requirements of the rooms all materials used within them need to be rust resistant.

Frogs from the same population can be collectively housed in large glass or plastic terrarium. To preserve genetic diversity frogs from different populations should not be

mixed. Adult frogs¹ are to be housed independent of juvenile frogs and recently metamorphosed individuals are to be kept separate from older juveniles during their first year of development.

Terraria are to be constructed from typical aquarium glass using aquarium sealant (for terrarium measurements see Figure 4.1a). In addition, a glass rail (Figure 4.1b) is to be installed around the entire inside perimeter of the terrarium for the aluminium framed lid (Figure 4.1c) to rest on. The rail provides a barrier to frogs which may climb up the sides of the terrarium and to crickets and other live frog food which may attempt escape by eating through the fly screen mesh on the lid.

Figure 4.1a: Construction plans for terraria.

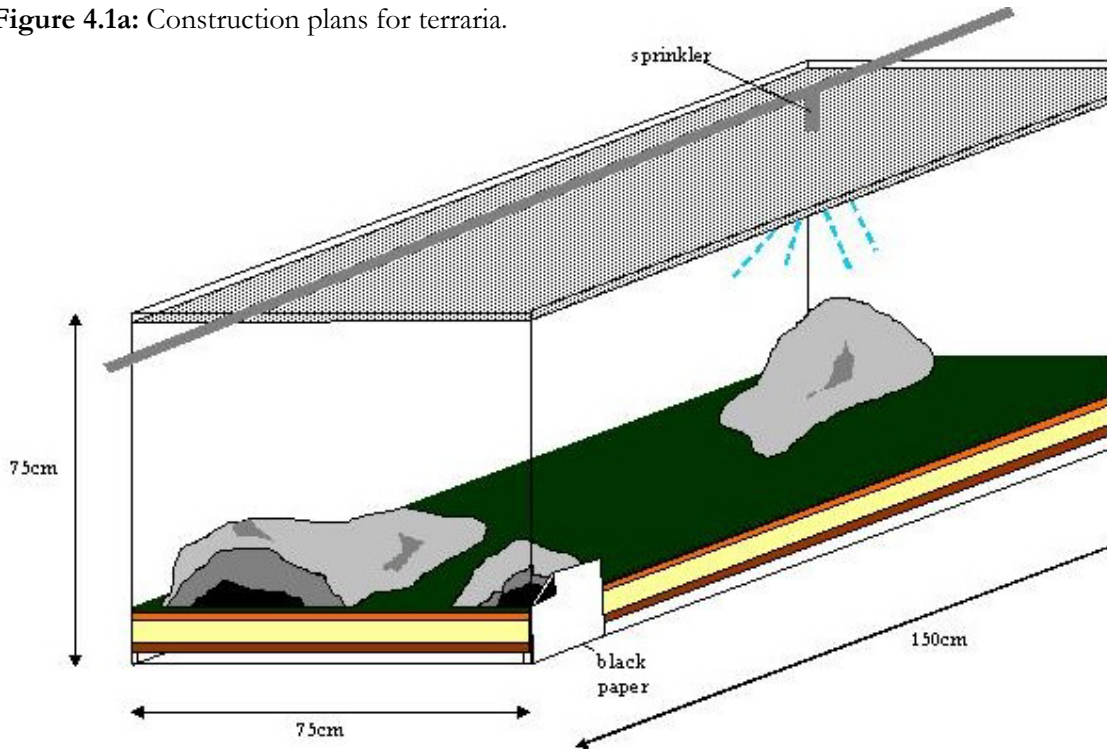

Figure 4.1b: Inside rail

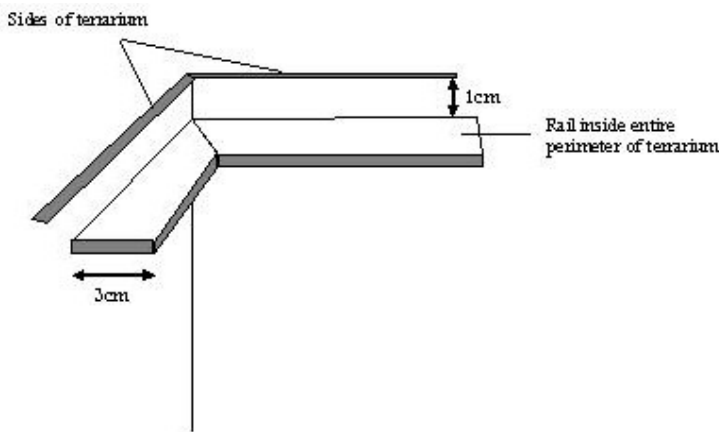
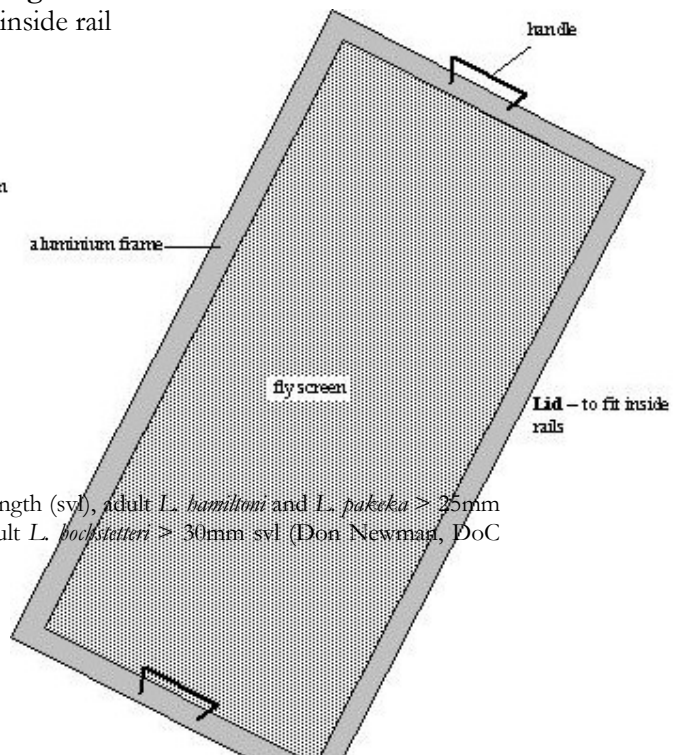

Figure 4.1c: Terrarium lid to fit onto inside rail



¹ Adult *L. archeyi* are defined as > 21 mm snout-vent length (svl), adult *L. hamiltoni* and *L. pakakea* > 25mm svl (Ben Bell, Victoria University, pers.comm.) and adult *L. bocksteini* > 30mm svl (Don Newman, DoC Wellington, pers. comm.).

Auckland Zoo:

Include plans of enclosures designed by Peter West using experience gained through visits and discussions with Melbourne Zoo, ARC and DOC team (including drainage, supports, building plan).

Grill is supported by columns of pvc pipe with a section removed to ensure drainage:



If a slope is required then supports are longer at the back than the front, ensuring that the substrate does not get too deep.

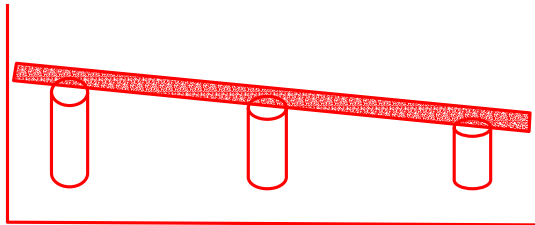

Nylon mesh is placed on top of grill to stop pebbles falling through. It may be necessary to place nylon mesh between pebbles and sand layers.

4.2 HOUSING FOR TERRESTRIAL SPECIES (*Leiopelma archeyi*, *L. hamiltoni*, *L. pakeka*)

4.2.1 *Densities*

Adult frogs should be housed at a maximum of 6 – 8 per square metre of terraria, whereas, juveniles could be housed at slightly higher densities. Terrarium depth should be a minimum of 50 cm from substrate to roof so as to offer sufficient height to enable frogs to climb objects.

4.2.2 *Substrate and Refuge*

Auckland Zoo:

Clay/soil and leaf litter have been collected from the Coromandel ranges, away from roads and uphill of tracks to avoid foreign contaminants.

All substrate and refuge materials collected from the wild must be thoroughly air-dried for at least three months before being used in terraria to avoid the inclusion of chytrid fungus sporangia. Alternatively, substrate materials can be autoclaved to ensure no chytrid is present, but this will also kill all potentially useful soil microbes.

Auckland Zoo:

Other methods of substrate sterilisation used: rocks and soil heated and held at 220°C for one hour; sand and gravel boiled for one hour.

Once substrate has been treated (autoclave, dry heat or boiling), it must be placed in a container with good ventilation, moistened and left for at least 30 days before use to allow dead organisms, etc to decompose.

Layers of different substrates are required to provide sufficient drainage and to prevent any backflow of water through the terraria (see Figure 4.2).

A shallow litter layer covers a layer of clay to provide substrate for burrowing. The clay layer must be kept shallow to prevent it from becoming too muddy. Beneath the clay lies a layer of (preferably white) sand and then a layer of pebbles for sufficient drainage.

Auckland Zoo:

If enclosures become “muddy” or water-logged, small areas of clay should be removed to allow water to escape from substrate.

Sterilized rocks provide refuge sites for frogs during daylight hours. Rocks can be cleaned using 0.5% chlorine solution then rinsed off with tap water and dried.

Auckland Zoo:

Chlorine should be used as a last resort as some frogs will not tolerate even minute quantities. (cf: Melbourne Zoo, personnel comment? name? And the ARC, Gerry Marantelli)

Place refuge sites on the edge of the glass with a piece of black cardboard stuck to the outside. The cardboard can be removed to see under the refuge when locating frogs without much disturbance to the hiding frogs (see Figure 4.1a).

Air dried fern stumps can be included in terraria for frogs to climb on. Plants grown inside the terraria from seed are safer alternatives than using plants grown in the wild.

Figure 4.2: Plan of terrarium for terrestrial species.

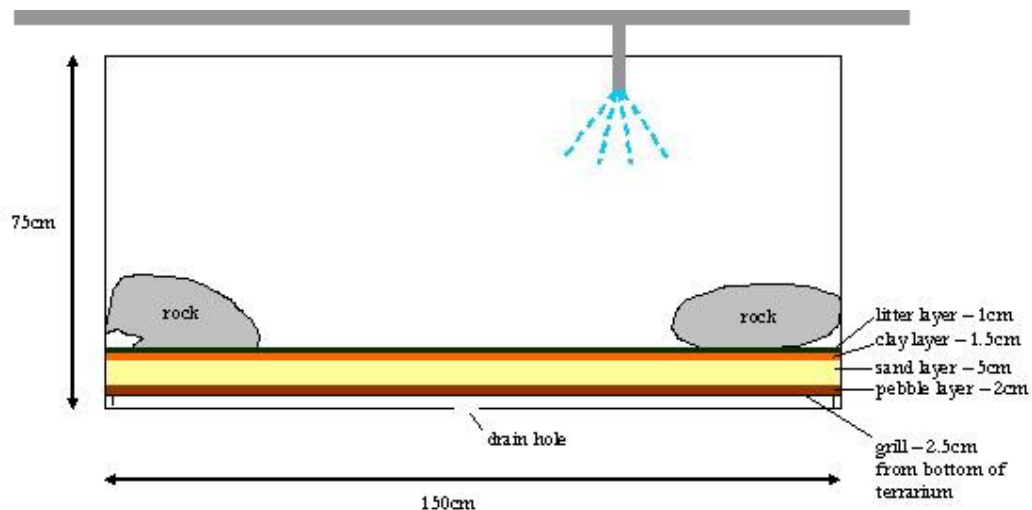

4.2.3 *Water*

A reverse osmosis water filtration system is to be used for all water used in native frog terraria and filters are to be replaced regularly. Water must not be shared between terraria and must not be recycled. The flow of water must be in one direction from the filter to the sprinklers then through the terrarium's substrate out the bottom drain hole and out of the room to be discarded. This is to prevent the inadvertent contamination of frogs from infected or dirty water.

Auckland Zoo:

Reverse osmosis water is kept in small holding tanks inside the building to allow water to cool to ambient room temperature prior to sprinkling enclosures. (Refer to plan)

4.2.4 *Humidity*

A constant 100% relative humidity is to be maintained within the room housing terraria using ultrasonic humidifiers. Each terrarium must be fitted with a sprinkler placed above one end so as to provide a choice of moistures along the clay.

Auckland Zoo:

A Nylex/Plessey sprinkler system has been installed with a single outlet at the centre of each enclosure. By changing the nozzle type, the area of the enclosure covered by the sprinkler can be changed to quarter, half or the full enclosure. (P West personal experience; refer to plan)

4.2.5 *Lighting*

Low heat white or fluorescent lighting is to be used to simulate daylight. Wide spectrum UV bulbs should not be used as it is expected that *Leiopelma* have low UV requirements due to their nocturnal habit. UV absorption is closely linked to calcium uptake and growth rates. *Leiopelma* have slow natural growth rates and an excess of UV may cause captive growth rates to outstrip the frogs' nutrient supply causing bone developmental problems.

Suggested bulbs to be used for day lighting: tri-polar NEC FL20SSBR/18-HG-T8 or comparable Sylvania bulb.

A small, dim (e.g. 15 watt) fluorescent tube is to be used to simulate moon light and should be angled towards the ceiling so the light is spread over the room. Day/night lighting must be maintained on a seasonally reflective photoperiod.

Auckland Zoo:

The 15-watt bulbs have been placed on timers which will be adjusted each month for seasonal variation.

4.2.6 *Temperature*

A refrigeration unit with monitored alarms is required to control the internal room temperature. Preferably one refrigeration unit per room or one unit with two separate outlets and controls is to be used.

Auckland Zoo:
Alarm is monitored by _____.

Terrariums must not be exposed to direct sunlight or large variations in temperature. As there is currently limited information on the required temperature ranges for maintaining native frogs under indoor captive management, broad temperature ranges based on temperature data recorded above ground, on-site and on point climate estimates are listed in Table 4.1. It is suggested that these temperature ranges should be followed in the first instance. If captive frogs display lethargy or are found dead an inappropriate temperature range may be a factor. In this circumstance the issue should be discussed with the captive coordinator who may advise that the temperature range should be adjusted.

As seasonal variation in temperatures may provide a cue for breeding this variation should be implemented into the temperature regime once more is understood about the optimum temperature ranges for survival of native frogs in the indoor captive environment (suggested seasonal temperature ranges can be found in Appendix 1).

Table 4.1: Suggested temperature ranges for terrestrial species (*L. archeyi*, *L. hamiltoni*, and *L. pakeka*)

Source location	Recommended temperature range*	Species
Waikato		
Northern Coromandel	10 - 17°C	<i>L. archeyi</i>
Central Coromandel	9 - 17°C	<i>L. archeyi</i>
Southern Coromandel	8 - 16°C	<i>L. archeyi</i>
Whareorino Forest	8 - 15°C	<i>L. archeyi</i>
Marlborough Sounds		
Stephens Island	8 - 18°C	<i>L. hamiltoni</i>
Maud Island	9 - 18°C	<i>L. pakeka</i>

*Temperature ranges for Whareorino Forest are from unpublished environmental data collected on site. Temperature ranges for Coromandel are from point climate estimates from the Landcare Research Land Environments of New Zealand (LENZ), John Leathwick, October 2002. Temperature ranges for Marlborough Sounds are from Newman et al. (1978).

4.3 HOUSING FOR SEMI-AQUATIC SPECIES (*Leiopelma hochstetteri*)

The semi-aquatic *Leiopelma hochstetteri* requires a similarly designed terrarium to the terrestrial species above with the addition of a shallow water pool and splash zone to simulate a stream environment. Cool water (10 - 14°C) is to be dropped over a large angled rock to provide a splash zone. The water can then pour into the shallow pool (2-5cm deep) which drains into the bottom cavity of the terrarium through a narrow drain hose at the bottom of the pool (see Figure 4.3). The water flow rate should be 75 – 100 times water change per day.

Figure 4.3: Plan of terrarium for semi-aquatic species.



4.3.1 Densities

Adult frogs should be housed at a maximum of 6 – 8 per square metre of terraria, whereas, juveniles could be housed at slightly higher densities.

4.3.2 Substrate and Refuge

In addition to directions given above for terrestrial species (4.2.2), the substrate surface needs to have a gentle slope towards the water pool providing a range of substrate moisture conditions from dry to very wet.

4.3.3 Water

See under 4.3.3.

4.3.4 Humidity

See under 4.2.4.

4.3.5 Lighting

See under 4.2.5.

4.3.6 Temperature

In addition to directions given above for terrestrial species (4.2.6), as there is currently limited information on the required temperature ranges for maintaining native frogs under indoor captive management, broad temperature ranges from point climate estimates are listed in Table 4.2. If captive frogs display lethargy or are found dead an inappropriate temperature range may be a factor. In this circumstance the issue should be discussed with the captive coordinator who may advise that the temperature range should be adjusted.

As seasonal variation in temperatures may provide a cue for breeding this variation should be implemented into the temperature regime once more is understood about the optimum temperature ranges for survival of native frogs in the indoor captive environment (suggested seasonal temperature ranges can be found in Appendix 1).

Table 4.2: Suggested temperature ranges for *L. hochstetteri*

Source location	Recommended temperature range*
Northland	

Brynderwyn Range	11 - 18°C
Waipu Gorge	11 – 19°C
Mareretu Forest	11 – 19°C
Auckland	
Warkworth	10 – 18°C
Waitakere Range	10 – 17°C
Hunua Range	9 – 17°C
Great Barrier Island	12 – 18°C
Waikato	
Northern Coromandel	10 - 17°C
Central Coromandel	9 - 17°C
Southern Coromandel	8 - 16°C
Rangitoto Range	8 - 14°C
Whareorino Forest	8 - 15°C
Bay of Plenty	
Kaimai Range	8 – 16°C
Otawa Forest	8 – 17°C
East Coast/Hawke’s Bay	
Motu River	8 – 17°C
Pukeamaru Range	9 – 17°C
Raukokore River	10 – 19°C
Raukumara Range	8 – 15°C
Waioeka river	8 – 18°C

* Temperature ranges are from point climate estimates from the Landcare Research Land Environments of New Zealand (LENZ), John Leathwick, October 2002.

4.4 CLEANING

To prevent disturbance to the frogs the substrate beneath the litter layer is only to be replaced when necessary (e.g. every few years) depending on its condition. If white sand is used then it will show up the build-up of nitrogenous waste which will indicate when it is time to clean the terrarium.

Auckland Zoo:
 Melbourne Zoo found that leaf litter and clay/soil stained the sand. We will “watch” the sand layer but also turn over small areas of substrate and monitor its odour on a weekly basis. If it is found to be contaminated by a high nitrogenous build up, etc the frogs must be removed and substrate changed (P West personal experience).

If parts of the litter layer start to breakdown then it may need to be replaced. Any new litter should first be thoroughly air dried for several months before being used in terraria. If the clay layer becomes too sludgy then it may also need to be replaced every year or so.

Auckland Zoo:
 Leaf litter will be added to the enclosures regularly (Melbourne Zoo and The ARC).
 If substrate becomes very sludgy, the frogs should be removed and substrate changed.

If possible use water only for cleaning. If something does require cleaning with chemicals then it must be cleaned outside the rooms containing terraria so as not to cause the chemical fumes to permeate the rooms. Cleaning sponges and equipment must be dedicated to each individual terrarium to prevent the spread of disease.

5 DIET

Live, laboratory bred or commercially obtained invertebrates must be fed to frogs about every second or third day. Care should be taken to ensure that a non contaminated food supply is used. The quantity required will depend on the type and size of prey as well as the individual sizes of the frog, and the temperate regime the frogs are being kept under (at warmer temperatures the frogs may require less food). Note that frogs can ingest a wide range of prey sizes and types. Food needs to be available to frogs before night time foraging begins.

Small micro-worms and mealworms should not be feed to frogs as they tend to hide, and later reproduce. Isopods (slaters/woodlice) appear not to be a preferred food (Ben Bell, Victoria University, pers. comm.).

Supplementary vitamins should not be required if an appropriate varied diet is followed. Invertebrates dusted with calcium powder will often have a chance to clean the powder off before being eaten by frogs.

Laboratory diaries must be maintained which include details of when, what and how much frogs are feed so feeding methods can be refined. Problems may occur if the frogs are being fed inappropriate food and or at the wrong times. Bell (1978a) suggested that an unusually high level of diurnal emergence in captive *L. archeyi* was a possible artefact of being fed on diurnally active houseflies. Other species in captivity that were fed nocturnal moths maintained more natural emergence patterns. At lower temperatures some food species may be inactive and are therefore not an attractive prey item for frogs. Care should be taken to observe what proportion of food is being consumed and whether frogs are losing weight.

5.1.1 *Adult frogs*

Adult frogs, typically, eat a range of hard-bodied and soft-bodied invertebrates (Eggers 1998). Variety should be provided where possible. This is particularly important prior to the breeding season as nutrition may play an important role in egg and clutch size (Ford and Seigel 1994; Girish and Saidapur 2000; Bell 2002).

Potential food items for adult frogs include:

Small, young crickets	<i>Drosophila</i> (vestigle winged)
Moths	Flies
Amphipods	Wax moth larvae
Coleopera (beetles)	Collembola (springtails)

5.1.2 *Juvenile frogs*

Juvenile frogs require soft-bodied invertebrates until they have grown to at least 20 mm snout vent length due to a lack of teeth (Eggers 1998).

Ideal food items for juvenile frogs include:

Drosophila (vestigle winged) Mites

Other small flies

Small wax moth larvae

6 QUARANTINE PROCEDURES

6.1 QUARANTINE

It is necessary to quarantine frogs that are to be taken from the wild into captive facilities, transferred between facilities or released into the wild from captivity so they can be monitored for any signs of illness.

In all cases, frogs that are transferred together must be quarantined at the same time. If new frogs are brought into the quarantine facility at any time during the quarantine period then the period must begin again from that point.

6.1.1 Wild to captive facility

Frogs are to be quarantined inside in isolation for a minimum of three months after removal from the field to establish which individuals are likely to be diseased. Even when diagnostic techniques are available to confirm if individual frogs are infected with chytrid fungus it is still recommended that apparent chytrid free frogs be quarantined for a minimum of three months. Frogs may take some time to show symptoms of chytrid infection or infection from other diseases.

6.2 ISOLATION

Quarantine facilities must be kept in a separate room from any existing or planned captive population enclosure. Water and/or air conditioning systems are not to be shared between these facilities.

6.3 HYGIENE

Virkon S® foot baths must be used and placed at each entrance/exit to the quarantine room. Foot baths should be covered when not in use and the solution changed regularly. Alternatively, dedicated pairs of shoes are to worn inside the quarantine room and removed before leaving.

A fresh pair of surgical gloves is to be used when handling each frog container or each frog (see section 8 Handling frogs). Gloves are to be rolled off so there is no contact between the outside of the gloves and the skin.

To prevent the possibility of cross contamination only one container lid should be removed at any one time. Containers must always be handled in the same order each day so if cross-contamination occurs is it only in one direction.

Quarantine containers must be thoroughly cleaned and sterilised with 70% ethanol. Time must be allowed for the ethanol to evaporate off the surface of the containers before frogs can be placed in them. All instruments used for servicing and measuring quarantined frogs must also be sterilised by being soaked in 70% ethanol before use for each frog.

6.4 HOUSING

Quarantined frogs should be housed individually in glass or plastic containers to prevent the spread of disease and to make it easier to monitor each frog's condition.

At present there are no tests which have proven to be accurate in the detection of chytrid fungus on live native frogs and there is no known treatment for successfully treating chytrid infection in native frogs. Both tests and treatments are currently under development at Canterbury University, Christchurch, New Zealand and at CSIRO Victoria, Australia.

Two possible scenarios have been identified 1) chytrid test and/or chytrid treatment is expected to become available (Figure 6.1) and 2) no chytrid test or treatment is expected to become available (Figure 6.2).

6.4.1 *Space and substrate*

Containers should be a minimum of 35 cm x 20cm x 20cm. Damp, non bleached paper towels or tissue are to be used to line the containers with some also scrunched up to provide refuge. Soiled paper towels are to be replaced once every two weeks(?).

Auckland Zoo:

DOC Team _____ have agreed to allow half of the frogs to be quarantined with man-made substrate (paper towels used by Dr Bruce Waldman, and capillary cloth used by Karen Eggers) and half on soil and leaf litter substrate (as used by Melbourne Zoo, The ARC and Peter West). In both cases the substrate will be changed weekly to avoid possible stress.

6.4.2 *Lighting*

See under 4.2.5.

6.5 CLIMATE

Humidity is to be maintained by misting using a spray bottle of reverse osmosis water. Enough ventilation for frogs should be supplied when container lids are removed for feeding or misting.

6.5.1 *Scenario 1: Chytrid test and/ or chytrid treatment is expected to become available*

Quarantine I

Frogs are to be kept in isolation from each other under chytrid suppression conditions if no test or treatment is available. This means keeping the frogs drier and at the lower end of the recommended temperature range (see Tables 4.1 and 4.2). Limited misting is only required to provide a very slightly damp substrate.

Quarantine II

Once a test for chytrid infection is available then after a frog tests negative for infection it is still to be kept in isolation from other frogs, but under captive colony climatic conditions (see 4.2.4; 4.2.6 and 4.3.6). If after at least 2 months under these conditions individual frogs show no sign of chytrid infection or other illness then they are to be tested again for chytrid infection. If they again test negative for chytrid then they are to be put into the captive colony (collectively housed in terraria as under 4.2 and 4.3).

If at anytime a frog tests positive for chytrid then they are to be treated immediately. If a treatment does not exist then the frogs are to be kept under chytrid suppression conditions until a treatment becomes available.

Figure 6.1: Flow chart for Scenario 1: Chytrid test and/or chytrid treatment is expected to become available.

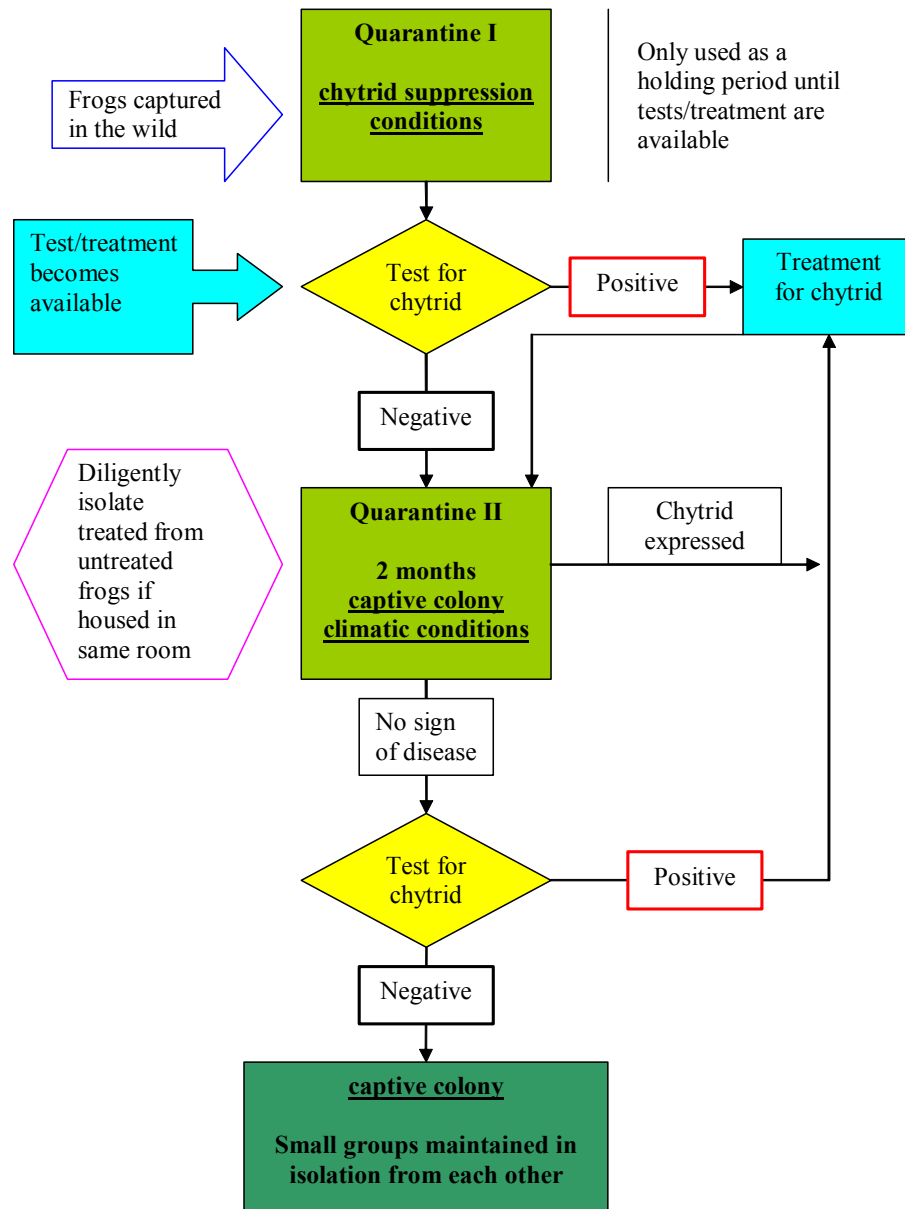

6.5.2 Scenario 2: No chytrid test or treatment is expected to become available

Quarantine I

If no chytrid test or treatment is expected to become available then the frogs are to be kept in isolation from each other for at least 2 months under captive colony climatic conditions (see 4.2.4; 4.2.6 and 4.3.6).

Quarantine IIa

If chytrid is expressed then the frogs are to be kept in isolation from each other under chytrid suppression conditions (see above).

Quarantine IIb

If chytrid is not expressed after at least two months in Quarantine (I) then the frogs should be kept in isolation from each other under an extension of captive colony climatic

conditions. This extension means that the frogs are to be kept at the upper limits of their temperature range. This will place more stress on the frogs in the hope that they express any diseases they may have.

If disease is not expressed in individual frogs after at least two months then they are to be put into the captive colony (collectively housed in terraria as under 4.2 and 4.3).

Figure 6.2: Flow chart for Scenario 2: No chytrid test or treatment is expected to become available.

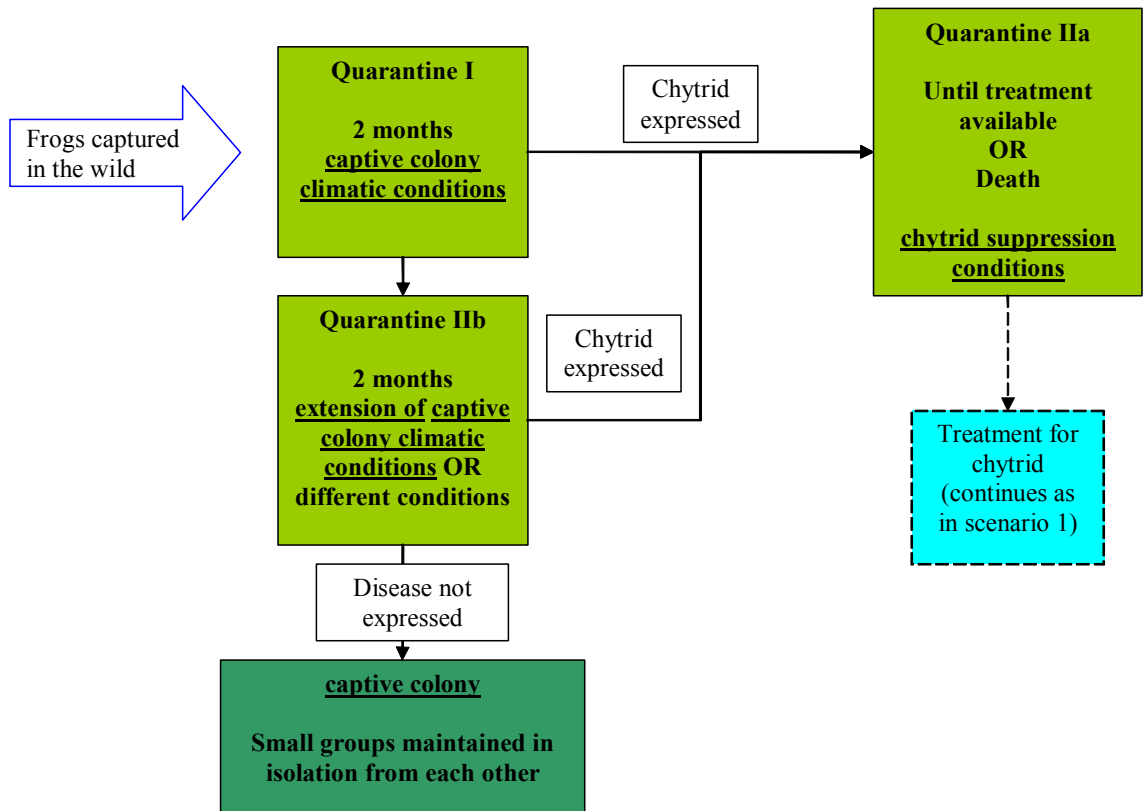

6.6 TRANSPORTATION

These guidelines should be followed when transporting or moving frogs from a source population to a quarantine environment, or between captive populations. During transportation, frogs should be maintained at relatively cool temperatures (8 - 10°C) throughout the entire journey to minimise stress.

6.6.1 Packing for transport

Leiopelma frogs are to be packed individually in separate, sterile containers or small plastic bags² for transport from the field or between captive or quarantine facilities. Each container should be a minimum of 15cm x 10cm x 5cm. Plastic bags must be filled with air to supply cushioning before being tied off at the top. Each container or plastic bag

² Containers will provide more structure and insulation when being packed into chilli bins, but frogs may be bruised against the sides of the container. Plastic bags should provide more cushioning but less structure and insulation.

must be lined with damp³ tissue paper with extra damp tissue paper provided as cushioning.

Frogs inside either containers or plastic bags can be transported from the field by being placed in small insulated boxes (i.e. chilly bins) containing cool pads to maintain a low temperature (8 - 10°C). These boxes can then be carried inside backpacks. Steps should be taken to minimise vibration transferred to the frogs whilst inside backpacks.

6.6.2 *Transportation between sites*

Auckland Zoo:

A new set of latex gloves should be used for each capture to avoid disease transfer.

Once removed from either the field or a captive facility transportation times must be minimised where possible, however delays are sometimes unavoidable. Cool pads should be replaced as often as necessary to maintain a constant low temperature (8 - 10°C). Thermometers can be used to monitor the temperature inside chilly bins during transport and further cool pads are to be added if temperature exceeds 15°C.

Chilly bins containing frogs should be kept out of direct sunlight and the opening of bins should be kept to a minimum. If an overnight wait is necessary in transit then frogs must be placed into temperature controlled fridges while remaining in their individual containers or plastic bags. If required the tissue paper in each container or bag may need to be replaced or dampened again. However, disturbance to the frogs should be kept to a minimum.

Frogs in chilly bins can be carried as luggage in the cargo hold on Air New Zealand flights if the airline is appropriately informed ahead of time. A request must be made to maintain the cargo hold temperature at around 10°C. If frogs are to travel by aeroplane then chilly bins will need to be labelled as fragile and containing live frogs to prevent them from being x-rayed.

6.6.3 *On arrival at captive facility*

Frogs are to be immediately placed into individual quarantine containers and should be left alone to settle. If coming from the field each frog should be weighed and measured two to three days after their arrival to allow time for any effects of dehydration or starvation to be alleviated.

Auckland Zoo:

Frogs should be weighed in the field when captured.

7 REPRODUCTION

Written by Paulette Dewhurst, Victoria University, Wellington and edited by Nadia Webster.

All four species lay eggs in nests where they remain, undergoing a period of direct intracapsular development from which a tailed froglet hatches (Turbott 1949; Stephenson 1955; Bell 1978b, 1985a). Fertilisation is believed to be external (Bell

³ When collecting from the field, water from the source location should not be used to dampen tissue paper as this may introduce chytrid fungus to the frog. Sparingly use aged tap water provided levels of aluminium and/or heavy metals aren't too high.

1985a). The males of the terrestrial species, *L. archeyi*, *L. hamiltoni* and *L. pakeka*, dorsally brood the larvae until metamorphosis (Archey 1922, Bell 1985a, 2002).

7.1 BREEDING

7.1.1 *Breeding Behaviour*

It is important to allow for the expression and retention of the full repertoire of natural behaviours in captive animals. Specific concerns for amphibians include the loss of defensive alkaloids in some species maintained or bred in captivity, which could affect re-introduction programmes (Cover *et al.* 1994).

Although it may be difficult to maintain behaviours that are suited to the environment of origin, considerations must be given to long-term evolutionary potential. It is not known what effects captivity may have on *Leiopelma*. To date, all successful breeding for *L. hochstetteri*, *L. hamiltoni* and *L. pakeka* has occurred in outdoor enclosures, with *L. archeyi* successfully breeding on both indoor terraria and outdoor pens (Bell 2002).

Correct social grouping can be an important factor in reproductive strategies. There have been observations reported of several *Leiopelma* being found together under the same rock (Stephenson and Thomas 1945; Eggers 1998). McLennan (1985) found four adult *L. hochstetteri* close to eggs at Otipi Stream, East Cape and suggested that the eggs may have been laid by more than one female.

The age at sexual maturity has been observed to be 4-5 years for *L. hamiltoni* and *L. pakeka*, 3-4 years for *L. archeyi* (Bell 1978).

7.1.2 *Breeding season*

Males of all species may breed annually, but females possibly only breed every second year, irrespective of a well-fed diet (Bell 2002). All species will breed only once in a season (Ben Bell, Victoria University, pers. comm.). The breeding season for each species is shown in Table 7.1.

Table 7.1 Field and captive breeding seasons for *L. archeyi*, *L. hamiltoni*, *L. pakeka*, and *L. hochstetteri*.

Species	Field observations	Captivity
<i>L. archeyi</i>	Sep to Nov (Bell 1985a)	Sep to Nov (Bell 2002)
<i>L. hamiltoni</i>	Oct to Dec (Bell 1985a)	Oct to Dec (Bell 2002)
<i>L. pakeka</i>	Oct to Dec (Bell 1978a, 1985a)	Oct to Dec (Bell 2002)
<i>L. hochstetteri</i>	Aug to Mar (Bell 1985a; McLennan 1985)	Aug to Feb (Bell 2002)

7.1.3 *Stimuli to breed*

Environmental factors:

In many amphibian species environmental stimuli such as heavy rainfall with mild temperatures induces breeding. However, it is not known if this is a factor influencing *Leiopelma*. Simulating rain and increasing the temperature immediately prior to the breeding season may prove to be beneficial (Bell 2002). More research is required in this area.

The amount of water sprinkled over terraria could be altered to reflect seasonal variations in water supply if seasonal variation is an important factor in triggering breeding (mean monthly precipitation).

Social factors:

Little is understood with regards to the social factors of breeding strategies, kin recognition, mate attraction and mate choice required by *Leiopelma* for successful breeding (Waldman and Tocher 1998). Group stimulus may be a factor, although a single pair of Whareorino *L. archeyi* housed together did breed successfully (Bell 2002).

There is no tympanum in *Leiopelma*, which also lacks some middle ear structures Stephenson (1961). This would indicate that vocalisations are not an important mechanism of communication for this genus. All species will emit shrill chirping sounds when threatened (Green, 1988). This form of calling has also been observed during the breeding season in both the field and in captivity by Bell (1978a). Cree and Daugherty (1991) also reported calling from apparently undisturbed frogs during the breeding season in field observations of both *L. archeyi* and *L. pakeka*. The role and nature of this type of calling is not fully known and requires further investigation.

It is also not known what factors may disturb reproductive activities in *Leiopelma*. It is recommended that disturbance during the breeding season should be kept to a minimum. Low intensity or red light can be used to observe breeding pairs of other amphibian species in the wild with little disturbance to mating behaviour or amplexus (Ed Meyer, University of Queensland, pers. comm.).

7.1.4 Oviposition sites

Males of *L. archeyi* and *L. pakeka/hamiltoni* have been observed occupying subsequent oviposition sites weeks, sometimes months, before eggs are laid (Bell 1978a). Choice of oviposition sites in anurans may be related to suitable microhabitats that reduce embryo mortality (Howard 1978).

Eggs in captivity for *L. archeyi* and *L. pakeka/hamiltoni* were laid in cool, moist shallow depressions under logs and stones similar to that observed in the field (Bell 1978a; Robb 1980).

L. hochstetteri select breeding sites that are wet muddy seepages near forest streams, which could be termed semi-aquatic with eggs being laid under stones or fallen vegetation (Turbott 1949; Stephenson 1955; Bell, 1978a). In the Warkworth area they have also been observed in holes in sodden banks made by larvae of the giant dragonfly (*Uropetala cavoriè*) (Turbott 1949).

7.1.5 Amplexus

Amplexus is in the inguinal (pelvic) position, where the male grips the female around the groin immediately anterior to the hind legs (Bell 1978a). Bell (1978a) has observed amplexus in *L. hochstetteri* on both land and in shallow water at the water's edge (away from the retreat site). This may be more physically demanding for the male than in other Leiopelmatid species and could explain the sexual dimorphism in this species (Ben Bell, Victoria University, pers. comm.). Observations have also been noted of brief mounting within each sex in some species, which in the case of female *L. archeyi* resulted in egg laying (Bell 1977, 1978a).

Hormonally induced breeding/amplexus is not considered advisable for stock kept for the purpose of captive breeding and rearing as experimental attempts at this have only produced infertile eggs (i.e. Stephenson and Stephenson, 1957; Cree and Daugherty 1991; Sharbel and Green, 1992).

7.1.6 Egg clusters

L. archeyi, *L. hamiltoni* and *L. pakeka* lay 1-19 eggs in moist areas under rocks, logs or vegetation (Bell 2002). Thurley (1996) also observed *L. archeyi* eggs in Whareorino Forest in the crown of a fern, but the cluster appeared to have been abandoned. *L. hochstetteri* lay 10-22 eggs in wet seepages, also under rocks, logs and vegetation (Bell 2002). Females from all four species produce egg strings from each ovary which often adhere into one cluster but eggs from each ovary can still be differentiated (Bell 1978a, 2002).

L. archeyi from the Coromandel in captivity have achieved greater clutch sizes than observed in the field, which may be attributable to a supplementary feeding regime for captive breeding stock (Bell, 2002).

7.1.7 Fertility rates

In captivity the overall fertility rate of eggs was 0.50 (13 clutches with a mean of 9.54 eggs per clutch) for *L. archeyi*, 0.73 (27 clutches with a mean of 11.44 eggs per clutch) for *L. pakeka* and 0.17 (14 clutches with a mean of 7.43 eggs per clutch) for *L. hamiltoni* (Bell 2002). Bell (2002) found that *L. archeyi* clutches attended by males have a higher overall fertility rate (0.85) than clusters without male brooding. Also clutch sizes tended to be larger when attended by males than in the wild (mean in the wild of 5.2 eggs per clutch compared with 9.1 eggs per clutch in captivity). In the wild, an overall mean fertility rate of 0.80 was determined from 16 clusters of *L. archeyi* (Bell 2002).

Few data are available at this time for *L. hochstetteri*, with only one recorded successful breeding event (1981/82 summer) that produced 9 hatched larvae (initial clutch size not known). Lower rates of success in breeding *L. hochstetteri* are possibly due to difficulties in recreating the natural habitat (Bell 1985b). Field data are also limited, but include a fertility rate of 0.82 for one clutch of 22 eggs (Bell 2002).

7.2 REARING

7.2.1 Parental care

Terrestrial species (*L. archeyi*, *L. pakeka*, *L. hamiltoni*):

After fertilisation, the males of the three terrestrial species remain at the nest site, brooding the developing egg cluster (Bell 1985a). This may have the benefit of maintaining a desirable moisture/humidity regime for the developing eggs (Stephenson and Stephenson 1957; Bell 1985a; Cree 1986), and possibly provides some protection against predation and microbial infection (Cree and Daugherty 1991).

Disturbance of brooding males should be kept to a minimum. In most cases when brooding *L. archeyi* males in the wild have been disturbed they have not abandoned the egg cluster if the retreat cover is replaced immediately and carefully (Bell 2002).

Field studies have shown that the larvae of the terrestrial species will usually remain with the ruptured egg capsules for a few days before climbing onto the male's back. The fluid

and jelly of the capsules may have possible anti-fungal and anti-bacterial properties (Bell 1985a).

After hatching, the larvae of the terrestrial species climb onto the dorsum and hind legs of the male (Bell 1985a), where they remain until their tails are fully absorbed, this is at 8-10 mm snout vent length for *L. archeyi*, and 12-13 mm for *L. hamiltoni* and *L. pakeka*. Removal of the juvenile frogs to nursery terraria (see 7.2.4) must occur shortly before froglets are ready to leave the male so the male parent can be identified and to minimize risks of possible cannibalism (Bell 2002). At this stage sibling juveniles should be kept apart for the rest of their captive care to prevent the possible effects of inbreeding (Bell 2002).

Semi-aquatic species (*L. hochstetteri*):

Males of this species do not appear to exhibit the same level of parental care of the eggs, but may remain close to the next site during egg development (Turbott 1949; Bell 1978, 1982a, b, 1985a)

There is only one record of *L. hochstetteri* breeding in captivity, where the eggs found in the outdoor enclosure were incubated and the larvae raised in petri dishes using creek water (Bell 2002). Bell (2002) also found five newly metamorphosed frogs around the edge of logs in January 1982, presumably from the same egg cluster. Adults were also present on the logs, therefore it is assumed that eggs and larvae can be maintained in the same enclosure as adults until removal to a nursery terraria (see 7.2.4) at metamorphosis (Ben Bell, Victoria University, pers. comm.).

7.2.2 Egg and larval development

Several studies detailing development from egg to metamorphosis have been published (Archey 1922, 1935; Turbott 1949; Stephenson 1951a, 1955; Stephenson and Stephenson 1957; Stephenson 1961; Bell 1977, 1978a,b, 1982a,b, 1985, 2002; Eggers 1998).

Development is intracapsular (within the egg) in all species, with large yolky, unpigmented eggs. The eggs are enclosed in a clear capsule comprised of an outer, tougher and initially somewhat adhesive coat, a middle gelatinous layer and an inner vitelline membrane (Bell, 1978a). Hatching commences when the end of the tail of the larvae pierces the egg wall, which is then ruptured by repeated vigorous flicks (Stephenson and Stephenson 1957; Eggers 1998). The hatchling is a tailed froglet and the tail gradually reduces until the froglet assumes anuran proportions for its limbs (Stephenson 1955).

Terrestrial species take 14-21 weeks to develop, dependent on ambient temperature. Hatching for captive *L. archeyi* occurred after 8-9 weeks and metamorphosis took a further 6-9 weeks (Bell 1978a, 1982a, 2002). Captive *L. hochstetteri* hatched sooner at around five weeks, with metamorphosis taking about a further 11 weeks (Bell 2002). *L. pakeka/hamiltoni* in captivity hatched after 7-10 weeks with metamorphosis completed in a further 11-13 weeks (Bell 1978a). The mean length of larvae and the snout-to-vent length (SVL) of the hatchlings for two captive-bred terrestrial species are shown in Table 7.2. Experience in rearing *L. hochstetteri* is still limited (Bell 2002).

Table 7.2: Mean lengths of captive bred frogs (extra-capsular larvae and immediately after metamorphosis; after Bell 1978a).

Species	Origin of parents	Mean length of larvae (mm)	Mean SVL of juvenile frog (mm)
<i>L. archeyi</i>	Whareorino	25.0 (<i>n</i> = 9)	10.6 (<i>n</i> = 8)
<i>L. archeyi</i>	Coromandel	20.1 (<i>n</i> = 26)	8.7 (<i>n</i> = 8)
<i>L. pakeka</i>	Maud Island	22.3 (<i>n</i> = 17)	11.2 (<i>n</i> = 9)

7.2.3 Incubation of eggs and larvae

It is recommended that eggs and larvae remain at or near the natural oviposition site for the dorsally brooding terrestrial species (Bell 2002). If eggs or hatchlings of the terrestrial species are discovered abandoned or eggs of *L. hochstetteri* are discovered, on-going development can be maintained if eggs are incubated.

Bell (1978a, 2002) maintained incubator temperatures for *L. archeyi* at $16.4 \pm 2.0^\circ\text{C}$, for *L. hamiltoni* at $10.8 \pm 2.6^\circ\text{C}$ and for *L. hochstetteri* at 15°C all with good success. Cree and Daugherty (1991) successfully incubated *L. archeyi* eggs at 18°C .

Egg clusters must be incubated intact in darkness. The clusters are to be kept in small glass or plastic containers, such as petri dishes on a bed of capillary matting or filter paper. Substrate water potential is an important consideration when incubating eggs (Cree 1986). *L. archeyi* eggs incubated on a near saturated substrate produced normal sized larvae that went on to complete metamorphosis (Cree and Daugherty 1991).

Tap water is not to be used as it contains many impurities and is not osmotically balanced (Bell 2002). Only reverse osmosis water is to be used to dampen the substrate and/or wash eggs or larvae.

If any egg should be broken the larvae is to be placed in a watch-glass with chilled (12°C) toad ringer solution for the rest of its development (see Appendix 2 for toad ringer solution). The toad ringer solution must be changed every second day and a glass slide placed on top of the watch-glass to prevent evaporation and concentration of the liquid (Eggers 1998).

Hatchlings tend to cluster together in the terrestrial species and are best left together in close contact as they might be on the male's back (Ben Bell, Victoria University, pers. comm.).

Eggs and larvae should be checked daily to see if development is progressing as expected. Infertile eggs or entire clusters have been observed in both captivity and the field (Stephenson 1955; Thurley 1996; Bell 2002). These may become infected with a fungus (Bell 1985a). Should infertile eggs develop a fungal growth, they should be removed from the egg cluster using a scalpel (Bell 2002). If dead larvae are found they are also to be removed from the cluster immediately.

Once metamorphosis is complete, with the yolk sac absorbed and tail fully reduced, juveniles can be removed from incubation and placed in nursery terraria (see 7.2.4). Feeding of small soft-bodied invertebrates can commence at this stage (see 5.1.2). Sibling

juveniles should be kept apart for the rest of their captive care to prevent the possible effects of inbreeding (Bell 2002).

7.2.4 Nursery terraria

Nursery terraria can be set up exactly the same as those for adult frogs (see section 4. Facilities). The addition of extra vegetation material (preferably grown from seed inside the terrarium) for the terrestrial species will provide extra refuge for juvenile frogs as Eggers (1998) found that young *L. archeyi* were common in vegetated daytime retreat sites, which changed to rocks and logs as the frogs reached maturity.

7.3 RECOMMENDED READINGS

1. Bell, B. D. 2002. Experience of captive breeding the four extant *Leiopelma* species. A report to the Native Frog Recovery Group, January 2002.

2. Cree, A., Daugherty, C. H. 1991. Induction of egg-laying in the terrestrial-breeding Leiopelmatid frogs. Unpublished report to the Science and Research Directorate, Department of Conservation.

- includes field observations of the breeding behaviour of *L. archeyi* and *L. pakeka* (Maud Island *Leiopelma*) and a description of *L. archeyi* egg incubation.

8 HANDLING FROGS

Handling of all frogs in captivity should be kept to a minimum to reduce the stress caused to the frog and drying out of frogs. When handling is necessary the following guidelines must be adhered to:

- All equipment must be soaked in 70% ethanol for at least 30 seconds before coming in contact with frogs. Alternatively equipment can be sterilised using an autoclave.
- A fresh pair of surgical gloves is to be used when handling each frog.
- Gloves must always be kept wet with water when handling frogs.
- Gloves are to be rolled off so there is no contact between the outside of the gloves and the skin.

9 MEDICAL ISSUES

9.1 HEALTH ASSESSMENT

A sick Leiopelmatid frog may:

- Behave abnormally e.g. be active by day, or inactive but clearly in the open
- Be very thin and/or losing weight
- Have abnormal skin or eyes or other physical deformities
- Move slowly
- Not attempt to right itself if turned onto its back

The temperature that the captive frogs are being kept at may also affect their weight, movement and ability to right themselves. At lower temperatures the frogs live food may slow down and may therefore become less attractive to eat. If this is the case then the frogs would show lethargy and weight loss (Gerry Marantelli, Amphibian Research Centre, pers. comm.). Also, at lower temperatures *Leiopelma* species tend to have very limited movement and are quite slow to right themselves if placed on their back (Nadia Webster pers. obs.).

9.2 MAIN HEALTH PROBLEMS

9.2.1 *Cutaneous Chytridiomycosis*

Chytrid fungal infection of frogs is an, often, fatal infection of the skin caused by *Batrachochytrium dendrobatids*. This fungal infection has been identified as one of the leading causes of severe decline in frog populations in Australia and North America (Daszak et al. 1999). Chytrid fungus has been isolated from dead *L. archeyi* frogs found in the wild.

Symptoms include the inability of frogs to right themselves when placed on their back, abnormal posture and excessive shedding of skin (Daszak et al. 1999). Although the larval stages of development can be infected with chytrid fungus, symptoms are not present until metamorphosis and adulthood. Suspected diseased individuals should be considered as infectious and must be immediately isolated.

A successful treatment of chytrid infected Leiopelmatid frogs has not been determined as yet. Investigations on *Leiopelma* species are currently underway at Canterbury University to determine a reliable test for chytrid infection and an effective treatment.

9.2.2 *Ranaviruses*

Closely related viruses of the *Ranavirus* genus cause Ranaviral infection in amphibians. This has not, as yet, been recorded infecting Leiopelmatid frogs.

Symptoms include decreased activity, fluid build-up under the skin, pinprick bleeding (focal haemorrhages) and death. This infection may occur at all stages of frog development.

9.2.3 *Red Leg*

This is caused by an initial bacterial infection with *Aeromonas hydrophila*. If abrasions or wounds occur to the skin susceptibility to infection increases. This has not, as yet, been recorded in Leiopelmatid frogs.

Symptoms include cutaneous ulcers and characteristic pinpoint haemorrhages over the abdomen, legs and tongue. Lethargy and emaciation are possible.

Diseased individuals should be removed immediately from the environment and isolated during treatment. Effective treatment by antibiotics is possible if symptoms are recognised early enough.

9.2.4 *Parasites*

Pathology of deceased Leiopelmatid frogs has shown that they maintain a relatively high gut parasite load in the wild with apparently little effect on their health (Richard Norman, Massey University, pers. comm.). However, the captive environment may provide extra stresses on frogs which could cause immunosuppression and the inability to cope with normal parasite loads.

9.3 NOTES ON MORTALITY

Bell (2002) has gained invaluable experience in housing captive colonies of Leiopelmatid frogs and some problems encountered are listed below:

- Failed temperature control on indoor enclosures where alarms were not in use resulted in the death of a number of frogs when the room temperature up to 26°C.

- Accidental escape of frogs from an outdoor enclosure.
- The use of tap water within frog enclosures where males were brooding eggs resulting in the haemorrhaging of larvae possibly due to the chlorine in the water.

9.4 DEATH AND DISPOSAL

All deaths of captive frogs are to be reported immediately to the Native Frog Captive Co-ordinator.

All dead frog specimens must be sent to a diagnostic centre for histological and pathological analysis as soon as possible and must be accompanied by a Dead Frog Submission Form (Appendix 3). A copy of this form is to be sent to the Captive Management Co-ordinator.

If frogs are found freshly dead (less than 6 hours) and it is suspected that they may have died from chytrid fungus then they should be immediately collected and placed in a labelled sterile container or bag and put into the fridge. Dr. Bruce Waldman must then be urgently contacted (see 12.5 for contact details) to arrange the transport of the freshly dead frog to Canterbury University. Freshly dead frogs that are infected with chytrid fungus are required for the culturing of the fungus for current research into chytrid treatment.

If frogs have been dead for more than 6 hours then an incision is to be made into the peritoneum to allow the preservative to enter the body cavity and then the specimen must be immediately placed in a labelled sterile jar and covered with 70% ethanol. A diagnostic centre (see 12.5) is then to be contacted to arrange the sending of the dead frog(s) for analysis.

Specimens are to be labelled with the frog's details: identification, captive facility name, date of collection from the wild and date of death.

Dead frog specimens must be lodged with the national museum (Te Papa) within two years of their death.

10 RECORDS AND REPORTING

For all facilities holding *Leiopelma* in captivity, a set of minimum data records are required to be completed on a six-monthly basis. These data will be stored on a SPARKS (Single Population Analysis Record Keeping System) database by the Dept. of Conservation. Reports are to be sent to the Captive Co-ordinator in March and September each year.

Reports must include as much of the below information as possible:

General information

- Identification number
- Sex (if known)
- Measured weights (g) and the dates they taken (monthly for quarantined frogs)
- SVL (snout-vent length in mm) and the dates it was measured (monthly for quarantined frogs)

- Identification numbers of other frogs housed in the same terrarium
- General notes

Husbandry

- Temperature range the frogs are being kept at (including dates and rate of change from daytime to night time temperatures)
- Diet
 - what time and temperature feeding takes place at
 - what and how much is being fed
 - what has been eaten (type of food and proportion)
- Quarantine
 - how often misting occurs (dates)
 - how often paper towels are changed (dates)
 - weekly records of condition (1 = emaciated, up to 5 = just had a huge feed or well gravid)

Behaviour

- postures noted during daytime/night time
- emergence patterns noted

Breeding

- identification of breeding pair (if possible)
- postures suggesting breeding behaviour (e.g. amplexus)
- description of nest site
- number of eggs laid in cluster
- fertility rate
- duration to hatching
- number successfully hatched
- observations of parental care
- duration to metamorphosis
- specific occurrences during development stage (i.e. abnormalities)
- number that successfully complete metamorphosis and transferred to nursery terraria
- which other individuals are in the same nursery terrarium

Handling

- how often and for what purpose

Health

- general health notes
- necropsy/histology reports for any deaths (appropriate to life stage)

11 RESEARCH NEEDS

Contact the Native Frog Recovery Group or the Native Frog Captive Co-ordinator (when one has been appointed) for guidance on specific research needs for captive *Leiopelma* species. In addition, a list of research priorities for the captive management of *L. archeyi* has been provided in the Draft Archey's Frog Captive Management Plan (Thurley and Webster 2002).

Further reproductive, developmental and behavioural studies in the field and in captivity for all species, but especially *L. bochstetteri*, are required. Skeletal chronology performed on wild collected toeclips can give information about natural growth rates and therefore give guidance for expected captive growth rates. Investigation into an appropriate individual captive identification method is also urgently required.

12 KEY CONTACTS

12.1 GENERAL HUSBANDRY

Bruce Waldman Canterbury University (03) 364 2066
 Email: b.waldman@zool.canterbury.ac.nz

Gerry Marantelli Amphibian Research Centre,
 Melbourne, Australia +61 3 9354 4718
 Email: arc@frogs.org.au

Nadia Webster Dept. of Conservation (07) 838 3363
 Email: nwebster@doc.govt.nz

12.2 BREEDING AND REARING

Ben Bell Victoria University (04) 463 5570
 Email: ben.bell@vuw.ac.nz

Karen Eggers Independent (09) 261 1829
 Email: karen.eggers@chh.co.nz

12.3 PERMITS

Department of Conservation
 Northland Conservancy (09) 430 2470
 Auckland Conservancy (09) 307 9279
 Waikato Conservancy (07) 838 3363
 Bay of Plenty Conservancy (07) 349 7400
 East Coast/Hawke's Bay Conservancy (06) 869 0460
 Nelson Marlborough Conservancy (03) 546 9335

12.4 HEALTH AND DISEASE

Bruce Waldman Canterbury University (03) 364 2066
 Email: b.waldman@zool.canterbury.ac.nz

Gerry Marantelli Amphibian Research Centre,
 Melbourne, Australia +61 3 9354 4718
 Email: arc@frogs.org.au

Nadia Webster Dept. of Conservation (07) 838 3363
 Email: nwebster@doc.govt.nz

Department of Conservation Conservancies (as listed above)

12.5 DIAGNOSTIC CENTRES FOR ANALYSIS OF DEAD FROGS

Bruce Waldman Canterbury University (03) 364 2066
 Email: b.waldman@zool.canterbury.ac.nz

Department of Zoology
University of Canterbury
Private Bag 4800
Creyke Road
Christchurch

Richard Norman Massey University (06) 350 7780
Email: r.norman@massey.ac.nz
Institute of Veterinary, Animal & Biomedical Sciences (IVABS)
Massey University
Fitzherbert Avenue
Private Bag 11222
Palmerston North

13 ACKNOWLEDGEMENTS

This manual would not have been possible without major contributions from Gerry Marantelli, Amphibian Research Centre, Melbourne, Australia (Section 4: Facilities; Section 6: Quarantine) and Paulette Dewhurst, Victoria University, Wellington (Section 7: Reproduction). Other contributors and reviewers include Karen Eggers, Ben Bell, Bruce Waldman, Don Newman, Mandy Tocher, Avi Holzapfel, Tertia Thurley, Ed Meyer, Alison Perfect. Diagrams for the construction of terraria were drawn by Janet Hodgetts.

14 REFERENCES

- Archey, G. 1922. The habit and life history of *Leiopelma hochstetteri*. *Rec. Canterbury (N.Z.) Museum* 2:59.
- Archey, G. 1935. Frogs in New Zealand. *Bulletin of the Auckland Zoological Society* 2: 5-8.
- Bell, B.D. 1977. Research uncovers more facts about rare native frogs. *Forest and Bird* 204: 12-17.
- Bell, B.D. 1978a. Observations on the ecology and reproduction of the New Zealand native frogs. *Herpetologica* 34: 340-354.
- Bell, B.D. 1978b. Breeding New Zealand's archaic frogs. *Wildlife* 20: 512-514.
- Bell, B.D. 1982a. The amphibian fauna of New Zealand. In D.G. Newman, (Ed.): *New Zealand Herpetology. New Zealand Wildlife Service Occasional Publications* 2: 27-89.
- Bell, B.D. 1982b. New Zealand frogs. *Herpetofauna* 14: 1-21.
- Bell, B.D. 1985a. Development and parental care in the endemic New Zealand frogs. In G. Grigg, R. Shine, and H. Ehmann (Eds.): *The Biology of Australasian Frogs and Reptiles*. Chipping Norton, New South Wales. Surrey Beatty & Sons. Pp. 269-278.
- Bell, B.D. 1985b. Conservation status of the endemic New Zealand frogs. In G. Grigg, R. Shine, and H. Ehmann (Eds.): *The Biology of Australasian Frogs and Reptiles*. Chipping Norton, New South Wales. Surrey Beatty & Sons. Pp. 449-458.

- Bell, B.D. 1994. A review of the status of New Zealand *Leiopelma* species (Anura: Leiopelmatidae), including a summary of demographic studies in Coromandel and on Maud Island. *New Zealand Journal of Zoology* 21: 341-349.
- Bell, B.D. 1999. Recent population declines of Archey's frog (*Leiopelma archeyi*) in the central Coromandel Range. Proceedings of the Society for Research on Amphibians and Reptiles in New Zealand, Abstracts. *New Zealand Journal of Zoology* 26:255.
- Bell, B.D. 2001. Recent population declines of Archey's frog *Leiopelma archeyi* in the central Coromandel Ranges. A report to the Native Frog Recovery Group, Department of Conservation, April 2001.
- Bell, B.D. 2002. Experience of captive breeding the four extant *Leiopelma* species. A report to the Native Frog Recovery Group, January 2002.
- Bull, P.C., Whitaker, A.H., 1975. The amphibians, reptiles, birds and mammals. In G. Kuschel (Ed.): *Biogeography and Ecology in New Zealand*. Dr W. Junk, The Hague. Pp. 231-276.
- Cree, A. 1986. Water relations of the endemic New Zealand frogs *Leiopelma archeyi*, *L. hamiltoni* and *L. hochstetteri*. Unpublished DPhil thesis, University of Waikato.
- Cree, A., Daugherty, C. H. 1991. Induction of egg-laying in the terrestrial-breeding Leiopelmatid frogs. Unpublished report to the Science and Research Directorate, Department of Conservation.
- Daszak, P., Berger, L., Cunningham, A.A., Hyatt, A.D., Green, D.E., Speare, R. 1999. Emerging Infectious Diseases and Amphibian Declines. *Emerging Infectious Diseases* 5(6). <http://www.cdc.gov/ncidod/eid/vol5no6/daszak.htm>
- Eggers, K. 1998. Morphology, ecology and development of Leiopelmatid frogs (*Leiopelma* spp.), in Whareorino Forest, New Zealand. Unpublished MSc thesis, Massey University.
- Ford, N.B., Seigel, R.A. 1994. Phenotypic plasticity: implications for captive-breeding and conservation programs In Murphy, J.B., Adler, K., Collins, J.T. (Eds.) *Conservation Management and Conservation of Amphibians and Reptiles*. Society for Studies on Amphibians and Reptiles.
- Gill, B. J., Whitaker, A. H. 1998. *New Zealand Frogs and Reptiles*. David Bateman Limited, Auckland, New Zealand.
- Girish, S., Saidapur, S.K. 2000. Interrelationship between food availability, fat body, and ovarian cycles in the frog, *Rana tigrina*, with a discussion on the role of fat body in anuran reproduction. *Journal of Experimental Zoology* 286: 487-493.
- Green, D.M. 1988. Antipredator behaviour and skin glands in the New Zealand native frogs, genus *Leiopelma*. *New Zealand Journal of Zoology* 15: 39-45.

- Green, D.M., Sharbel, T.F., Hitchmough, R.A., Daugherty, C.H. 1989. Genetic variation in the genus *Leiopelma* and relationships to other primitive frogs. *Zeitschrift für Zoologische Systematik und Evolutionsforschung* 27: 65-79.
- Hay, J.M., Ruvinsky, I., Hedges, S.B., Maxson, L.R. 1995. Phylogenetic relationships of amphibian families inferred from DNA sequences of mitochondrial 12S and 16S ribosomal RNA genes. *Mol. Biol. Evol.* 12:928-937.
- Howard, R.D. 1978. The influence of male-defended oviposition sites on early embryo mortality in bullfrogs. *Ecology* 59(4): 789-798.
- McLennan, J.A. 1985. Some observations on Hochstetter's frog in the catchment of the Motu River, East Cape. *New Zealand Journal of Ecology* 8: 1-4.
- Mitchell, N., Bell, B.D., Carver, S. 2001. October Interim report on the investigation of factors influencing the status and decline of Archey's frog in the Coromandel Ranges. An unpublished report to the Department of Conservation, Science and Research Division.
- Molloy, J., Bell, B., Clout, M., de Lange, P., Gibbs, G., Given, D., Norton, D., Smith, N., Stephens, T. 2002. Classifying species according threat of extinction; a system for New Zealand. Biodiversity Recovery Unit, Department of Conservation, Wellington.
- Newman, D.G., Crook, I.G., Imboden, C.H. 1978. Comparisons of the climates of the two habitats of Hamilton's frog. *New Zealand Journal of Ecology* 1: 84-90.
- Newman, D.G. 1977a. Hamilton's Frog. *Wildlife – a review* 8: 48-53.
- Newman, D.G. 1977b. Some evidence of the predation of Hamilton's frog (*Leiopelma hamiltoni* (McCulloch)) by tuatara (*Sphenodon punctatus* (Grey)) on Stephens Island. *Proceedings of the New Zealand Ecological Society* 24: 43-47.
- Newman, D.G., 1996. Native Frog (*Leiopelma* spp.) Recovery Plan. *Threatened Species Recovery Plan* No. 18. Department of Conservation, Wellington. 40p.
- Rabb, G.B. 1999. The Amphibian Decline Phenomenon. A speech given in Cincinnati, May 1999. <http://elib.cs.berkeley.edu/aw/declines/index.html>
- Robb, J. 1980. *New Zealand Amphibians and Reptiles*. Collins, Auckland.
- Sharbel, T.F., Green, D.M. 1992. Captive maintenance of the primitive New Zealand frog, *Leiopelma hochstetteri*. *Herpetological Review* 23(3): 77-79.
- Stephenson, N.G. 1951a. On the development of the chondrocranium and visceral arches of *Leiopelma archeyi*. *Trans. Zool. Soc. London* 27:203-253.
- Stephenson, N.G. 1951b. Observations on the development of the amphicoelous frogs, *Leiopelma* and *Ascaphus*. *J. Linn. Soc. (Zool.) London* 42:18-28.
- Stephenson, N.G. 1955. On the development of the frog, *Leiopelma hochstetteri* Fitzinger. *Proc. Zool. Soc. Lond.* 124:785-795.

- Stephenson, E.M. 1961. New Zealand native frogs. *Tuatara* 8: 99-106.
- Stephenson, E.M, Stephenson, N.G. 1957. Field observations on the New Zealand frog, *Leiopelma* Fitzinger. *Trans. Royal Soc. New Zealand* 84:867-882.
- Thurley, T. 1996. A survey of native frogs (*Leiopelma archeyi* and *L. hochstetteri*) in Whareorino Forest, northern King Country. MA (Applied) in Environmental Studies thesis, Victoria University of Wellington.
- Thurley, T., Webster, N. 2002. Draft Archey's Frog Captive Management Plan. Department of Conservation, Waikato Conservancy, Hamilton.
- Turbott, E.G. 1949. Discovery of the breeding habits of *Leiopelma hochstetteri* Fitzinger. *Records of the Auckland Institute and Museum* 3:373-376.
- Waldman, B. 2001. Chytridiomycosis in New Zealand Frogs. *Surveillance* 28(3): 9 – 11.
- Waldman, B.; Tocher, M. 1998. Behavioural ecology, genetic diversity, and declining amphibian populations *In* Caro, T. (Ed.), Behavioural Ecology and Conservation Biology. Oxford University Press, Oxford.

15 APPENDICES

15.1 APPENDIX 1: SEASONAL TEMPERATURE RANGES

Source location	Recommended temperature range			
	Summer Dec - Feb	Autumn Mar - May	Winter Jun - Aug	Spring Sep - Nov
Northland*				
Brynderwyn Range	14 - 22°C	12 - 19°C	8 - 14°C	10 - 17°C
Waipu Gorge	14 - 23°C	2 - 20°C	8 - 15°C	10 - 18°C
Mareketu Forest	14 - 23°C	12 - 20°C	8 - 15°C	10 - 18°C
Auckland*				
Warkworth	13 - 22°C	11 - 19°C	7 - 14°C	9 - 17°C
Waitakere Range	13 - 22°C	11 - 19°C	6 - 13°C	9 - 16°C
Hunua Range	12 - 21°C	10 - 17°C	5 - 12°C	8 - 16°C
Great Barrier Island	14 - 22°C	13 - 19°C	9 - 14°C	10 - 17°C
Waikato*				
Northern Coromandel	13 - 22°C	11 - 18°C	6 - 13°C	9 - 16°C
Central Coromandel	12 - 22°C	10 - 18°C	5 - 13°C	8 - 17°C
Southern Coromandel	12 - 21°C	9 - 17°C	5 - 12°C	8 - 16°C
Rangitoto Range	10 - 19°C	7 - 15°C	3 - 9°C	5 - 14°C
Whareorino Forest	11 - 19°C	9 - 16°C	4 - 10°C	7 - 14°C
Bay of Plenty*				
Kaimai Range	12 - 19°C	9 - 17°C	4 - 11°C	7 - 15°C
Otago Forest	12 - 20°C	9 - 18°C	5 - 13°C	8 - 17°C
East Coast/Hawke's Bay*				
Motu River	13 - 22°C	9 - 18°C	4 - 13°C	8 - 17°C
Pukeamaru Range	13 - 21°C	10 - 18°C	6 - 13°C	8 - 16°C
Raukokore River	14 - 22°C	11 - 19°C	6 - 14°C	9 - 18°C
Raukumara Range	12 - 20°C	9 - 16°C	4 - 11°C	7 - 15°C
Waioeka river	12 - 22°C	8 - 19°C	3 - 13°C	7 - 17°C
Marlborough Sounds**				
Stephens Island	16 - 20°C	13 - 15°C	8 - 9°C	11 - 13°C
Maud Island	17 - 19°C	13 - 15°C	8 - 9°C	12 - 13°C

* Temperature ranges are from point climate estimates from the Landcare Research Land Environments of New Zealand (LENZ), John Leathwick, October 2002.

** Temperature ranges for Marlborough Sounds are from Newman et al. (1978).

15.2 APPENDIX 2: TOAD RINGER SOLUTION

(After Eggers 1998):

To make a 0.9% Solution:

Sodium Chloride	6.5g/litre	
Calcium Chloride	5ml/litre	(2.4% solution)
Potassium Chloride	3ml/litre	(4.2% solution)
Sodium Hydrocarbonate	2ml/litre	(5.0% solution)
Sodium Hydrophosphate	0.2ml/litre	(5.0% solution)
Glucose Solid	1g/litre	

Solutions to be made up with distilled water.

Mix all together and immerse tadpole.

Recommendations: keep solutions chilled (12°C) and fresh. Change regularly.

15.3 APPENDIX 3: DEAD FROG SUBMISSION FORM

FROG SUBMISSION FORM

(Please fill in as many details as you can)

SAMPLE NUMBER.....

SENDER'S NAME AND ADDRESS

TELEPHONE..... FAX.....

EMAIL.....

SPECIES..... STAGE (circle one) ADULT JUVENILE

TADPOLE

LENGTH Snout-vent..... WEIGHT.....

DATE & TIME COLLECTED.....DATE

SUBMITTED.....

LOCATION WHERE FOUND (Grid

Ref.).....

TYPE OF

ENVIRONMENT.....

ARE PESTICIDES etc

USED?.....

ABNORMAL BEHAVIOUR.....

.....

EFFECT OF

HANDLING.....

ABNORMAL APPEARANCE:

Skin.....

Eyes.....Orifices.....Other.....

.....

ARE OTHER FROGS ILL?.....

PROPORTION OF FROGS

AFFECTED.....

IS FINDING ILL/DEAD FROGS A COMMON

OCCURRENCE?.....

EUTHANASED?.....

HOW?.....

FIXATIVE USED (if any)?.....

FROZEN?.....WHAT TEMPERATURE?

TIME FROM DEATH TO AUTOPSY/FREEZING.....

IF CAPTIVE, HAS ANY MEDICATION/DISINFECTANT BEEN

USED?.....

COMMENTS.....

.....

.....

.....

.....

.....

.....Thank you for your cooperation.